

The Peaktronics SUB-101 subpanel provides an easy way to mount Peaktronics 3-phase driver components in an external housing for 3-phase actuator applications. The SUB-101 is designed to directly mount in a Bud AN-1310 NEMA 4 enclosure, and comes with the hardware to mount the subpanel, an SSD-100 3-phase Solid State Driver, an XFR-100 Actuator Controls Transformer, and an accessory relay (see below).

#### ASSEMBLY DIAGRAM

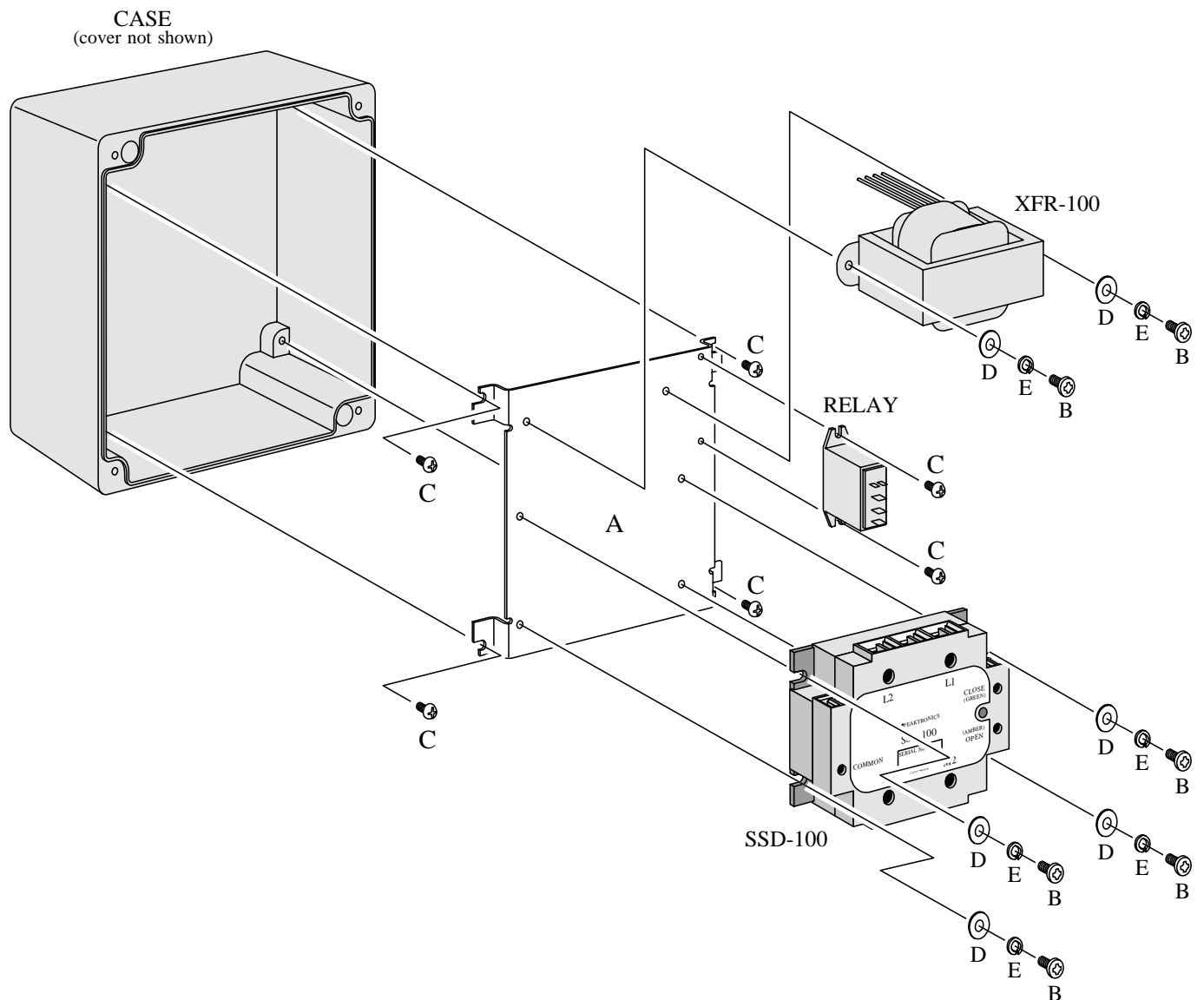

## PACKAGE CONTENTS

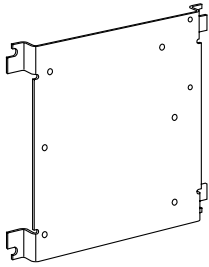

A

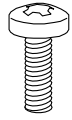

B



C



D



E

ITEM	QTY	DESCRIPTION
A	1	subpanel
B	6	#8-32 x 0.375" pan head screw
C	6	#6-32 x 0.25" self-tapping pan head screw
D	6	#8 flat washer
E	6	#8 split ring lockwasher

## OUTLINE

